

# General Specifications

## Electrical Capacity (Resistive Load)

**Power Level (silver):** 3A @ 125V AC or 3A @ 250V AC or 3A @ 30V DC  
**Logic Level (gold):** 0.4VA maximum @ 28V AC/DC maximum  
 (Applicable Range 0.1mA ~ 0.1A @ 20mV ~ 28V)  
 Note: Find additional explanation of operating range in Supplement section.

## Other Ratings

**Contact Resistance:** 50 milliohms maximum for silver; 100 milliohms maximum for gold  
**Insulation Resistance:** 200 megohms minimum @ 500V DC  
**Dielectric Strength:** 1,000V AC minimum between contacts for 1 minute minimum;  
 1,500V AC minimum between contacts & case for 1 minute minimum  
**Mechanical Life:** 1,000,000 operations minimum for momentary circuit  
 200,000 operations minimum for maintained circuit  
**Electrical Life:** 100,000 operations minimum  
**Nominal Operating Force:** Single pole: 1.47N for nonsealed; 1.67N for sealed  
 Double pole: 2.75N for nonsealed; 2.94N for sealed  
**Contact Timing:** Nonshorting (break-before-make)  
**Travel:** Pretravel .059" (1.5mm); Overtravel .059" (1.5mm); Total Travel .118" (3.0mm)

## Materials & Finishes

**Housing/Bezel:** Glass fiber reinforced polyamide (UL94V-0)  
**Snap-in Frame:** Stainless steel  
**Base:** Glass fiber reinforced polyamide (UL94V-0)  
**Movable Contactor:** Phosphor bronze with silver or gold plating  
**Movable Contacts:** Silver alloy with silver plating or brass with gold plating  
**Stationary Contacts:** Silver alloy or copper with gold plating  
**Switch Terminals:** Phosphor bronze with tin plating  
**Lamp Terminals:** Phosphor bronze with tin plating

## Environmental Data

**Operating Temperature Range:** -25°C through +50°C (-13°F through +122°F) for Illuminated  
 -25°C through +70°C (-13°F through +158°F) for Nonilluminated  
**Humidity:** 90 ~ 95% humidity for 96 hours @ 40°C (104°F)  
**Vibration:** 10 ~ 55Hz with peak-to-peak amplitude of 1.5mm traversing the frequency range & returning in 1 minute; 3 right angled directions for 2 hours  
**Shock:** 50G (490m/s<sup>2</sup>) acceleration (tested in 6 right angled directions, with 5 shocks in each direction)  
**Sealing:** IP65 of IEC60529 standard for panel seal models

## Installation

**Mounting Torque:** 0.785Nm (6.95 lb•in) maximum  
**Quick Connect Force:** 24.5N maximum downward force on connector  
**Soldering Time & Temperature:** Manual Soldering: See Profile A in Supplement section.

## Standards & Certifications

**Flammability Standards:** UL94V-0 housing & base  
**UL:** **File No. E44145 - Recognized only when ordered with marking on switch.**  
 Add "/U" or "/CUL" before first dash in part number to order UL recognized switch.  
 All solder lug models recognized at 3A @ 125/250V AC or 0.4VA @ 28V AC/DC maximum.  
**CSA:** **File No. 023535\_0\_000 - Certified only when ordered with marking on switch.**  
 Add "/C" before first dash in part number to order CSA certified switch.  
 All solder lug models certified at 3A @ 125/250V AC or 0.4VA @ 28V AC/DC maximum.

# Distinctive Characteristics

Full face or spot illumination with incandescent lamps or multi-element LEDs, with or without resistors.

Choice of super bright LEDs in white, green, and blue as well as bright LEDs in red, amber, and green.

Combination bezel-barrier is an integral part of the switch and prevents accidental actuation.

Unique thermoplastic elastomer seal inside caps plus rolled sleeve of nitrile butadiene rubber at joining of housing and inner case, all for added protection to interior mechanism.

Dust and oil tight as well as splashproof panel seal models qualify to IP65 of IEC60529 Standards (similar to NEMA 4 and 13). Panel seal models provided with exterior o-ring.

Distinctive design of snap-action contacts for shock resistance, long life, and sensitive actuation.

High density design to give behind panel depth of less than one inch.

Terminals are epoxy sealed to lock out flux, dust, solvents, and other contaminants.

Latchdown for indication of circuit status, plus audible, tactile feedback with smooth, responsive operation.

Matching indicators available.

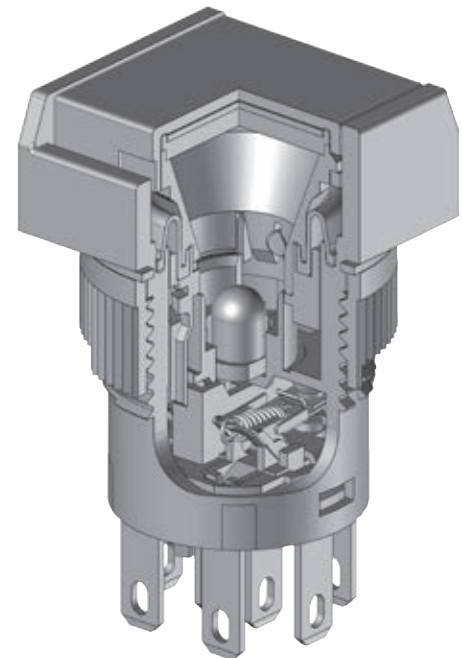

Actual Size

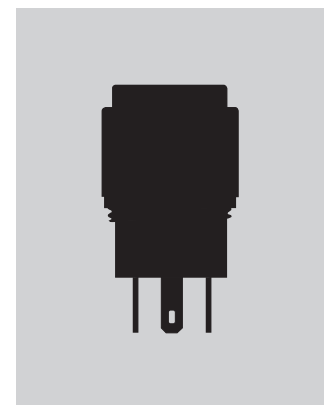

### TYPICAL SWITCH

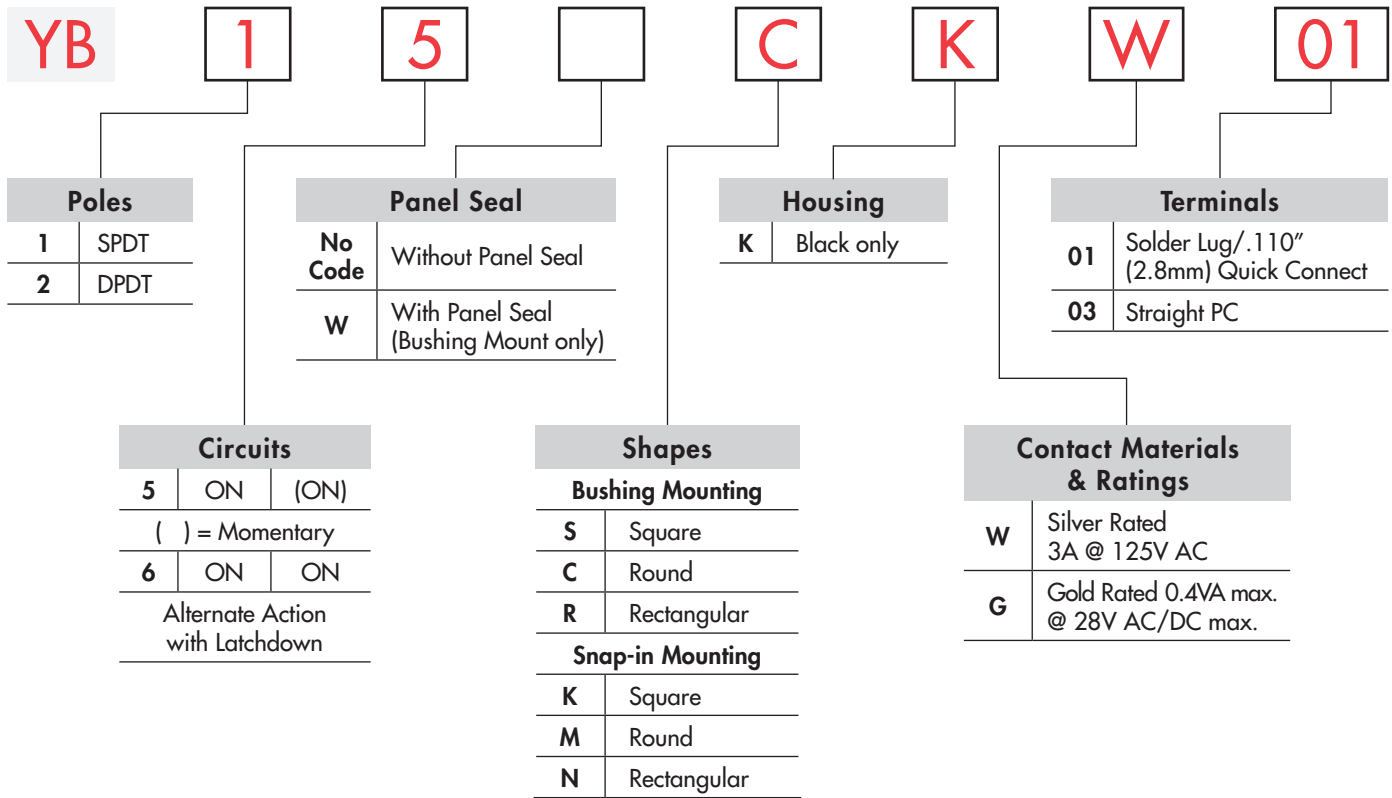

#### IMPORTANT:



Switches are supplied without UL & cULus marking unless specified.  
**UL & cULus recognized only when ordered with marking on switch.**  
 Specific models, ratings, & ordering instructions are noted on the General Specifications page.

#### DESCRIPTION FOR TYPICAL ORDERING EXAMPLE

#### YB15CKW01-6F-JB

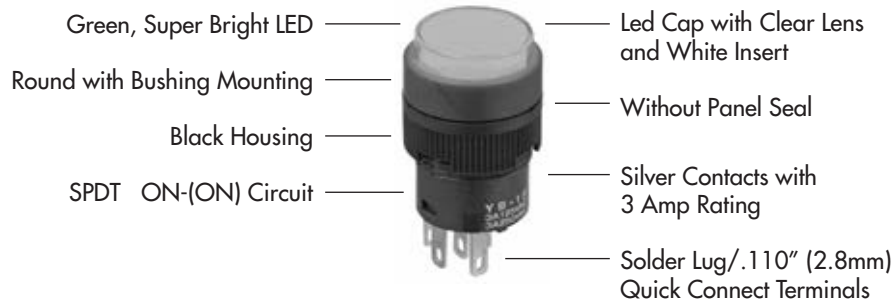

Toggles  
Rocker  
Pushbuttons  
Illuminated PB  
Programmable  
Keylocks  
Rotaries  
Slides  
Tactiles  
Tilt  
Touch  
Indicators  
Accessories  
Supplement

## ORDERING EXAMPLE

6 F

JB

### Lamps

#### Incandescent Lamp

<b>05</b>	5-volt
<b>12</b>	12-volt
<b>No Code</b>	Nonilluminated

#### LED for Spot Illuminated Cap

LED Colors		Forward Voltage	
<b>1C</b>	Red	<b>02</b>	2-volt (no resistor)
<b>1D</b>	Amber		
<b>1F</b>	Green		
<b>1CF</b>	Red/Green	<b>12</b>	12-volt
		<b>24</b>	24-volt

#### Bright LED

LED Colors		Resistor	
<b>5C</b>	Red	<b>No Code</b>	No Resistor
<b>5D</b>	Amber	<b>05</b>	5-volt
		<b>12</b>	12-volt
<b>5F</b>	Green	<b>24</b>	24-volt

#### Super Bright LED

<b>6B</b>	White
<b>6F</b>	Green
<b>6G</b>	Blue

#### Bicolor LED for Full Face Illuminated

LED Colors		Forward Voltage	
<b>2CF</b>	Red/Green	<b>02</b>	2-volt (no resistor)
		<b>05</b>	5-volt
		<b>12</b>	12-volt
		<b>24</b>	24-volt

### Cap Types & Colors

#### Solid Cap: Lens/Insert Colors

<b>BB</b>	White/White
<b>CB</b>	Red/White
<b>EB</b>	Yellow/White
<b>FB</b>	Green/White
<b>GB</b>	Blue/White

#### Spot Illuminated Cap: Lens/Insert Colors

<b>JA</b>	Clear/Black
<b>JB</b>	Clear/White
<b>JC</b>	Clear/Red
<b>JE</b>	Clear/Yellow
<b>JF</b>	Clear/Green

#### LED Cap: Lens/Insert Colors

<b>JB</b>	Clear/White
<b>JC</b>	Clear/Red
<b>JD</b>	Clear/Amber
<b>JF</b>	Clear/Green

#### LED Cap: Lens/Insert Colors

<b>JB</b>	Clear/White
-----------	-------------

#### LED Cap: Lens/Insert Colors

<b>JB</b>	Clear/White
-----------	-------------

Toggle

Rocker

Pushbutton

Illuminated PB

Programmable

Keylocks

Rotaries

Slides

Tactiles

Tilt

Touch

Indicators

Accessories

Supplement

### POLES & CIRCUITS

Pole	Model	Plunger Position ( ) = Momentary		Connected Terminals		Throw & Switch/Lamp Schematics
		Normal	Down	Normal	Down	
SP	YB15 *YB16	ON ON	(ON) ON	1-3	1-2	Notes: Switch is marked with NC, NO, COM, L+, L-. Lamp circuit is isolated and requires external power source. 
DP	YB25 *YB26	ON ON	(ON) ON	1-3 4-6	1-2 4-5	

\* When in latchdown position for the alternate circuit, cap position is .020" (0.5mm) above the built-in bezel.

### PANEL SEAL

**No Code**

Without Panel Seal

**W**

With Panel Seal

Bushing Mounting

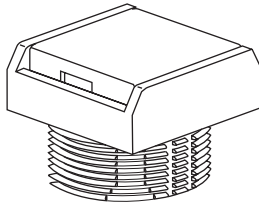

Supplied with mounting nut.

Snap-in Mounting

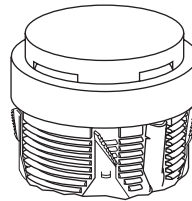

Bushing Mounting only

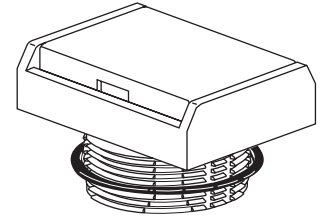

Supplied with mounting nut and o-ring AT089.

### SHAPES & MOUNTING TYPES

Bushing Mounting

Snap-in Mounting

**S**

Square

**C**

Round

**R**

Rectangular

**K**

Square

**M**

Round

**N**

Rectangular

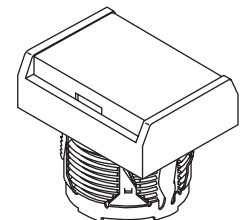
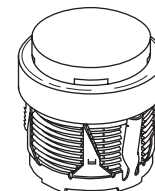
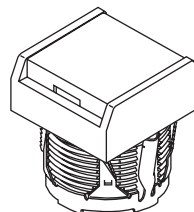
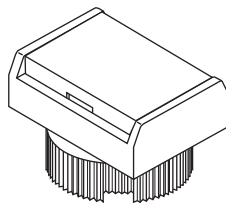
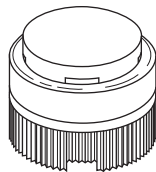
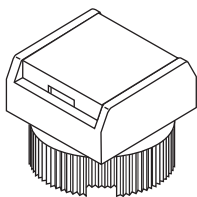

Bezel-barrier is an integral part of the switch body.

### HOUSING

**K**

Black

Housing available in black only. The 1-piece body and bezel-barrier have a matte finish.

### CONTACT MATERIALS & RATINGS

**W**

Silver Contacts

Power Level

3A @ 125/250V AC

**G**

Gold Contacts

Logic Level

0.4VA max. @ 28V AC/DC max.

Complete explanation of operating range in Supplement section.

## TERMINALS

**01** Solder Lug/  
.110" (2.8mm) Quick Connect

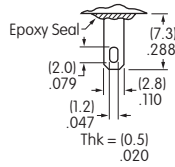

**03** Straight PC

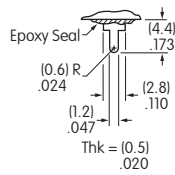

Single Pole

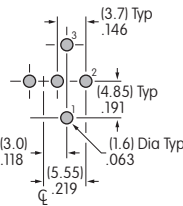

Double Pole

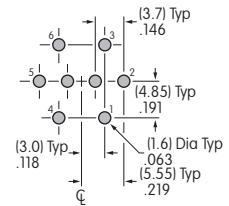

## INCANDESCENT LAMP & SOLID CAP

Electrical specifications are determined at a basic temperature of 25°C. Lamp circuit is independent of switch operation. For dimension drawing of lamp see the Accessories & Hardware section.

<b>AT611</b>  T-1 Bi-pin		<b>05</b>	<b>12</b>	
	Voltage	V	5V AC	12V AC
	Current	I	115mA	60mA
	MSCP		.150	.150
	Endurance	Hours	7,000 average	
	Ambient Temperature Range		-25°C ~ +50°C	

**No Code** No Lamp

### Solid Cap for Incandescent Lamp & Nonilluminated

Lens/Insert  
Colors Available:

- BB** White/White
- CB** Red/White
- EB** Yellow/White
- FB** Green/White
- GB** Blue/White

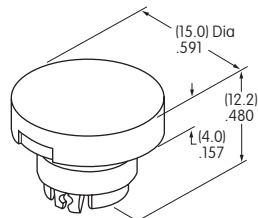

**AT3002**  
Round

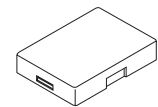

Translucent Colored Lens

**AT3001**  
Square

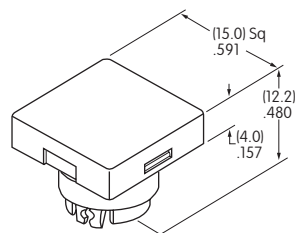

**AT3003**  
Rectangular

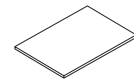
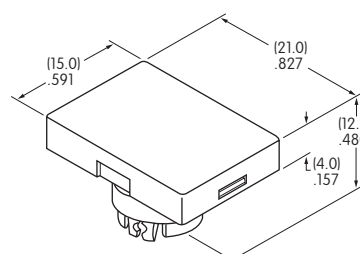

Translucent White Insert

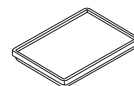

Translucent White Seal/Filter



Incandescent Lamp AT611

**Materials:**

Lens & Insert: Polycarbonate Seal/Filter: Thermoplastic Elastomer

### SPOT ILLUMINATED CAP WITH BUILT-IN LED

This spot-illuminated cap is factory assembled.

**AT3010**  
Square

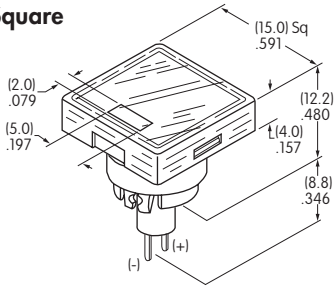

**AT3011**  
Round

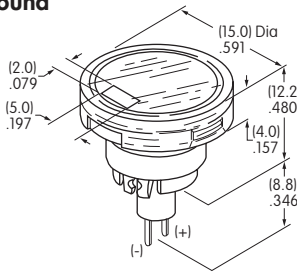

**AT3012**  
Rectangular

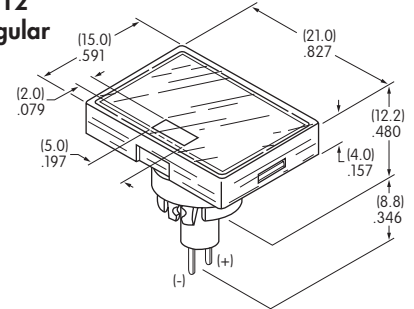

**Colors Available:**

<b>1C</b> Red	<b>1D</b> Amber	<b>1F</b> Green	<b>1CF</b> Red/Green
------------------	--------------------	--------------------	-------------------------

		<b>02</b> Without Resistor Red or Amber	<b>02</b> Without Resistor Green or Red/Green	<b>05</b> With Resistor All Colors	<b>12</b> With Resistor All Colors	<b>24</b> With Resistor All Colors	Unit
Maximum Forward Current	$I_{FM}$	20	20	15	15	12	mA
Typical Forward Current	$I_F$	15	15	12.5	12.5	10	mA
Forward Voltage	$V_F$	1.9	2.1	5	12	24	V
Maximum Reverse Voltage (not applicable to bicolor)	$V_{RM}$	5	5	5	5	5	V
Current Reduction Rate Above 25°C	$\Delta I_F$	0.27	0.27	—	—	—	mA/°C
Ambient Temperature Range		-25 ~ +50					°C

Without Resistor 2-volt

With Resistor 5, 12, 24-volt

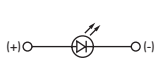

Single Color

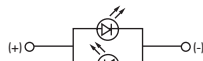

Bicolor

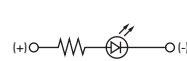

Single Color

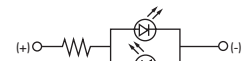

Bicolor

The electrical specifications shown are determined at a basic temperature of 25°C. LED circuit is isolated and requires external power source. Single color LEDs are colored in OFF state. Bicolor LED is translucent white in OFF state.

If the source voltage exceeds the rated voltage, a ballast resistor is required.  
The resistor value can be calculated by using the formula in the Supplement section.

**Lens/Insert**  
**Colors Available:**

<b>JA</b>	Clear/Black
<b>JB</b>	Clear/White
<b>JC</b>	Clear/Red
<b>JE</b>	Clear/Yellow
<b>JF</b>	Clear/Green



Clear Lens

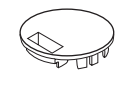

Colored Insert



Seal

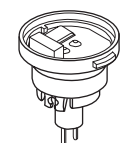

Built-in LED  
(integral part  
of the cap)

Example part number  
when cap is ordered separate  
from switch:

**AT3010F02JA**

for a  
Square Spot Illuminated Cap  
with Green 2-volt LED  
without resistor  
Clear Lens and Black Insert

**Materials:**

Lens & Insert: Polycarbonate  
Seal: Thermoplastic Elastomer

## BRIGHT LED & LED CAPS

The electrical specifications shown are determined at a basic temperature of 25°C.  
 LED circuit is isolated and requires external power source.  
 If the source voltage exceeds the rated voltage, a ballast resistor is required.  
 The resistor value can be calculated by using the formula in the Supplement section.

### Electrical Specifications for Bright LED without Resistor

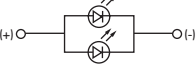
<b>Bright AT628</b>      T-1 Bi-pin	<b>Colors Available:</b> <span style="border: 1px solid black; padding: 2px;">5C</span> Red <span style="border: 1px solid black; padding: 2px;">5D</span> Amber <span style="border: 1px solid black; padding: 2px;">5F</span> Green <span style="border: 1px solid black; padding: 2px; margin-left: 20px;">No Code</span> No Resistor	Unit				
	LED Colors	Red	Amber	Green		
	Maximum Forward Current	$I_{FM}$	40	40	40	mA
	Typical Forward Current	$I_F$	26	26	26	mA
	Forward Voltage	$V_F$	1.9	2.0	2.0	V
	Maximum Reverse Voltage	$V_{RM}$	4	4	4	V
	Current Reduction Rate Above 25°C	$\Delta I_F$	0.50			mA/°C
	Ambient Temperature Range	-25 ~ +50			°C	

### Electrical Specifications for Bright LED with Resistor

<b>Bright AT634</b>    T-1 1/4 Bi-pin	<b>Colors Available:</b> <span style="border: 1px solid black; padding: 2px;">5C</span> Red <span style="border: 1px solid black; padding: 2px;">5D</span> Amber <span style="border: 1px solid black; padding: 2px;">5F</span> Green <span style="border: 1px solid black; padding: 2px; margin-left: 20px;">05</span> <span style="border: 1px solid black; padding: 2px; margin-left: 20px;">12</span> <span style="border: 1px solid black; padding: 2px; margin-left: 20px;">24</span>	Unit				
	Maximum Forward Current	$I_{FM}$	—	—	—	mA
	Typical Forward Current	$I_F$	25	20	10	mA
	Forward Voltage	$V_F$	5	12	24	V
	Maximum Reverse Voltage	$V_{RM}$	4	8	16	V
	Current Reduction Rate Above 25°C	$\Delta I_F$	—	—	—	mA/°C
	Ambient Temperature Range	-25 ~ +50			°C	

AT634  
5-volt,  
2-element  
with Resistor

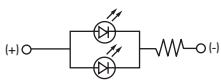

AT634  
12-volt,  
4-element  
with Resistor

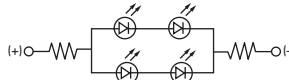

AT634  
24-volt,  
4-element  
with Resistor

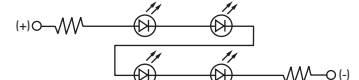

### Cap for Bright LED

Lens/Insert  
Colors Available:

- JB Clear/White
- JC Clear/Red
- JD Clear/Amber
- JF Clear/Green

**AT3004**  
Square

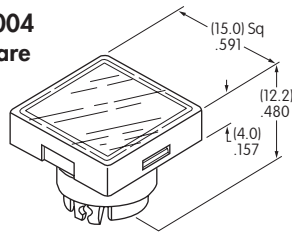

**AT3005**  
Round

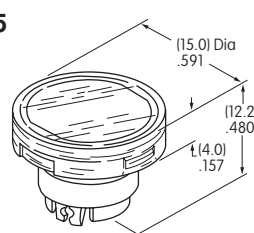

**AT3006**  
Rectangular

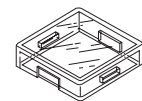
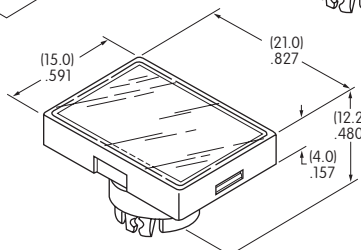

Transparent Clear Lens

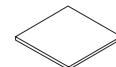

Translucent Colored Insert

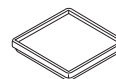

Translucent White Seal/Diffuser



Bright LEDs  
AT628 AT634

**Materials:**



Lens & Insert: Polycarbonate Seal/Diffuser: Thermoplastic Elastomer



### SUPER BRIGHT LED & LED CAPS

The electrical specifications shown are determined at a basic temperature of 25°C.  
 LED circuit is isolated and requires external power source.  
 If the source voltage exceeds the rated voltage, a ballast resistor is required.  
 The resistor value can be calculated by using the formula in the Supplement section.

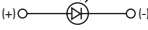
#### Electrical Specifications for Super Bright LED

Super Bright AT625G Blue AT631B White AT632F Green			6B	6F	6G	Unit
			Colors:	White	Green	
 T-1 Bi-pin	Maximum Forward Current	$I_{FM}$	30	30	30	mA
	Typical Forward Current	$I_F$	20	20	20	mA
	Forward Voltage	$V_F$	3.3	3.3	3.3	V
	Maximum Reverse Voltage	$V_{RM}$	7	7	7	V
	Current Reduction Rate Above 25°C	$\Delta I_F$	0.40	0.40	0.40	mA/°C
	Ambient Temperature Range			-25 ~ +50		°C

#### Cap for Super Bright LED

**AT3014**  
Square

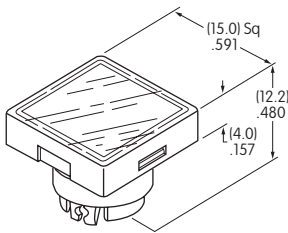

**AT3015**  
Round

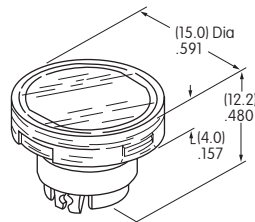

**AT3016**  
Rectangular

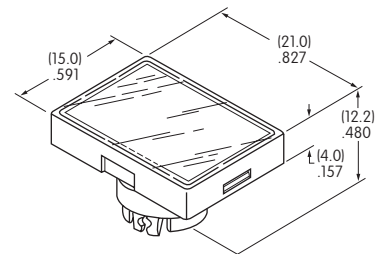

Lens/Insert  
Colors Available:

**JB** Clear/White

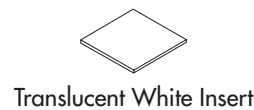

Super Bright LEDs  
AT625 AT631  
AT632

**Materials:**  
 Lens & Insert: Polycarbonate Seal/Diffuser: Thermoplastic Elastomer

Toggles  
 Rockers  
 Pushbuttons  
 Illuminated PB  
 Programmable  
 Keylocks  
 Rotaries  
 Slides  
 Tactiles  
 Tilt  
 Touch  
 Indicators  
 Accessories  
 Supplement

## BICOLOR LED & LED CAPS

The electrical specifications shown are determined at a basic temperature of 25°C.  
 LED circuit is isolated and requires external power source.  
 If the source voltage exceeds the rated voltage, a ballast resistor is required.  
 The resistor value can be calculated by using the formula in the Supplement section.

### Electrical Specifications for Bicolor LED

<b>Bicolor AT621</b>  T-1 1/2 Bi-pin						Unit	
	Bicolor LED is translucent white in OFF state.		<b>02</b>	<b>05</b>	<b>12</b>	<b>24</b>	
	Maximum Forward Current	$I_{FM}$	60	60	20	12	mA
	Typical Forward Current	$I_F$	45	45	15	10	mA
	Forward Voltage (Red/Green)	$V_F$	1.9 / 2.1	5	12	24	V
	Current Reduction Rate Above 25°C	$\Delta I_F$	0.80	—	—	—	mA/°C
Ambient Temperature Range		-25 ~ +50				°C	

AT621  
 Bicolor LED  
 2-volt  
 6-element  
 without Resistor

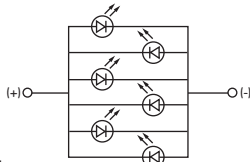

AT621  
 Bicolor LED  
 5-volt  
 6-element  
 with Resistor

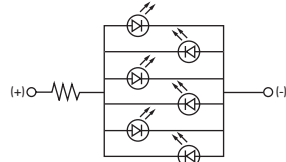

AT621  
 Bicolor LED  
 12 & 24-volt  
 6-element  
 with Resistor

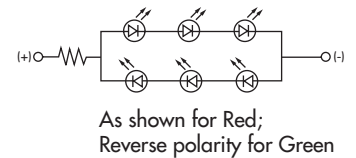

### LED Caps

**AT3004**  
 Square

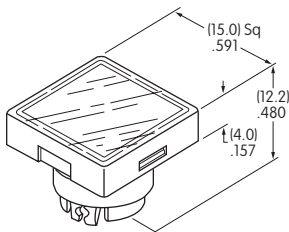

**AT3005**  
 Round

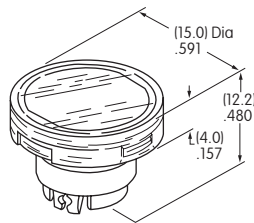

**AT3006**  
 Rectangular

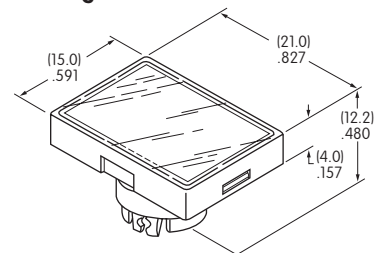

Lens/Insert  
 Colors Available:

**JB** Clear/White

Transparent Clear Lens

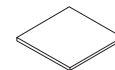

Transparent White Insert



Translucent White Seal/Diffuser



Bicolor LED AT621

Materials:

Lens & Insert: Polycarbonate Seal/Diffuser: Thermoplastic Elastomer

## TYPICAL SWITCH DIMENSIONS

### Square • Bushing Mounting

### Single & Double Pole

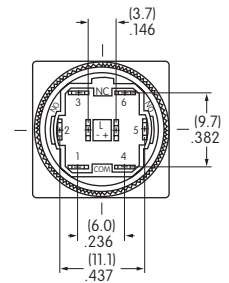
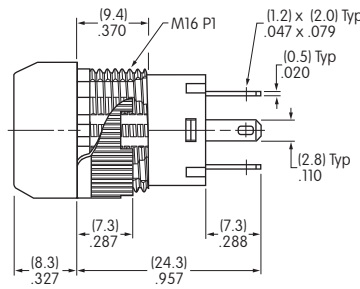
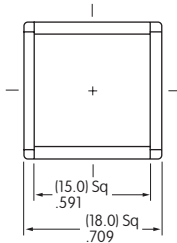

**YB15SKW01-12-CB**

Single pole models do not have terminals 4, 5, & 6.

### Round • Panel Seal

### Single & Double Pole

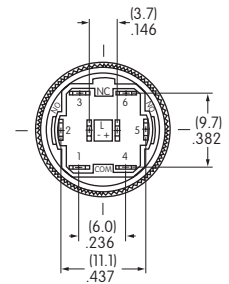
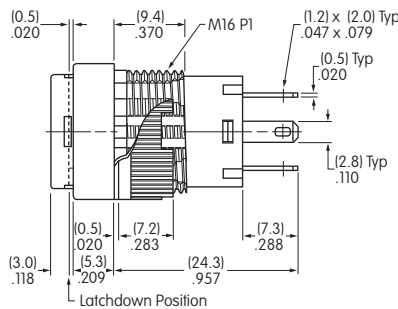
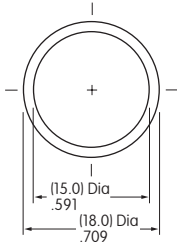

**YB26WCKW01-12-EB**

Single pole models do not have terminals 4, 5, & 6.

### Rectangular • Snap-in Mounting

### Single & Double Pole

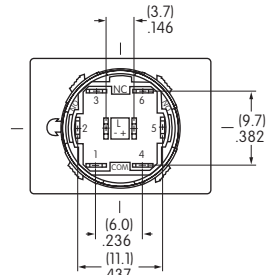
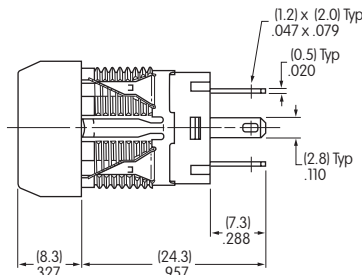
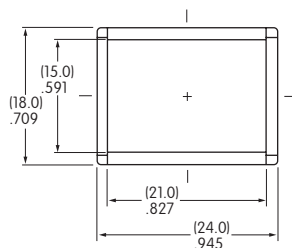

**YB15NKW01-5C-JC**

Single pole models do not have terminals 4, 5, & 6.

## PANEL THICKNESS & CUTOUTS

### Bushing & Panel Seal Mount

Panel Thickness  
.020" ~ .197"  
(0.5mm ~ 5.0mm)

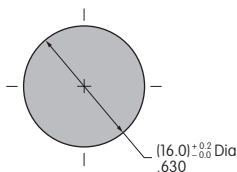

### Snap-in Mount

Panel Thickness  
.039" ~ .138"  
(1.0mm ~ 3.5mm)

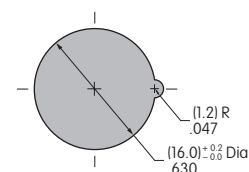

## OPTIONAL ACCESSORIES

Dust Covers and Protective Guards reduce depth of switch behind panel by .047" (1.2mm).

**Panel Thickness Range with Dust Cover or Protective Guards:**

Bushing Mounting  
.020" ~ .150" (0.5mm ~ 3.8mm)

Snap-in Mounting  
.020" ~ .091" (0.5mm ~ 2.3mm)

Panel Seal  
.020" ~ .118" (0.5mm ~ 3.0mm)

### AT4115 Dust Cover for Snap-in or Bushing Mount

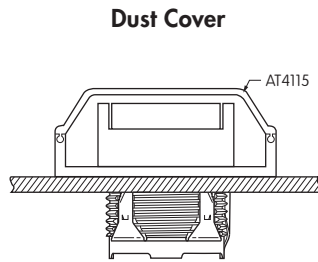

### Dust/Splash Cover

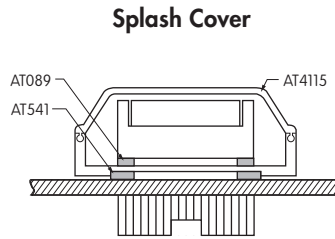

### AT4115 Splash Cover and AT541 O-ring for Bushing Mount

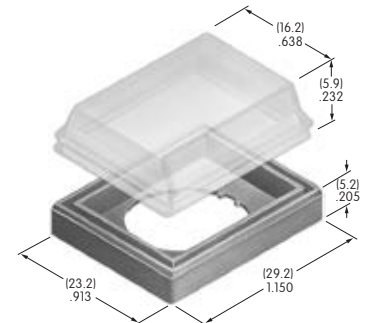

**AT4115**

**Materials:**  
Lid: Polyvinyl Chloride  
Base: Polyamide  
O-ring: Nitrile butadiene rubber

Snap-in Mount

Panel Seal

Note: AT089 o-ring supplied with panel seal model.

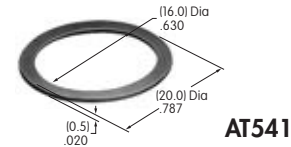

**AT541**

### AT4072 Protective Guard

Opens 90°  
Closes manually



### Protective Guard

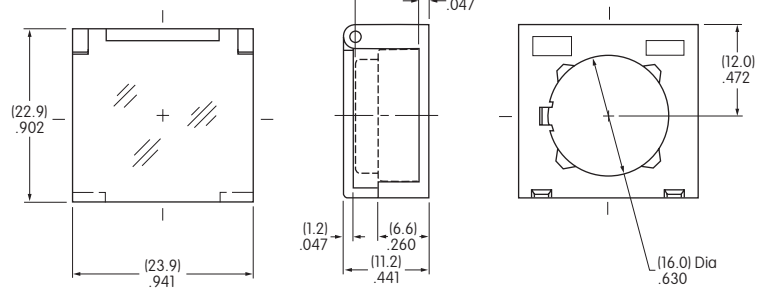

**Materials:**  
Lid: Polycarbonate  
Base: Glass Fiber Reinforced Polycarbonate

### AT4175 Spring Loaded Protective Guard

Opens 180°  
Closes automatically



### Spring Loaded Protective Guard

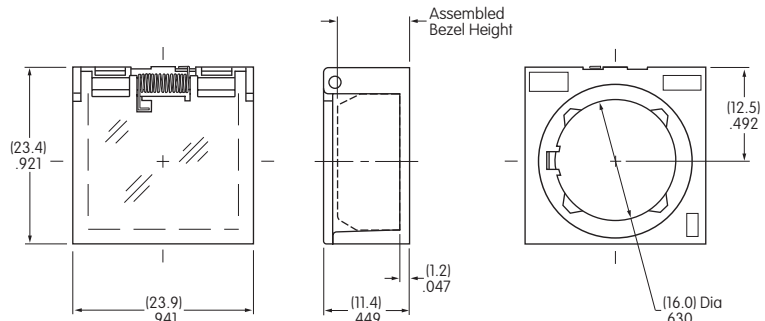
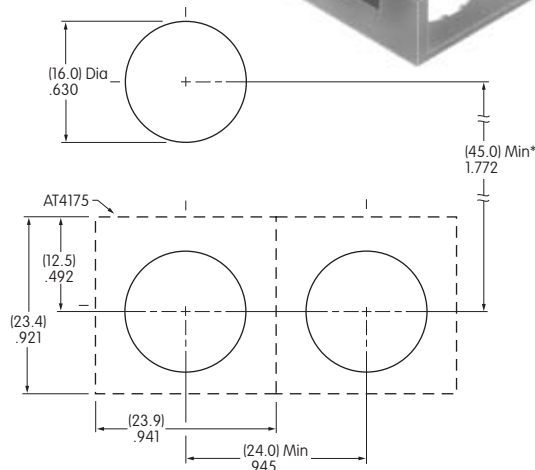

**Materials:**  
Lid: Polycarbonate  
Base: Glass Fiber Reinforced Polyamide  
Coil Spring: Stainless Steel

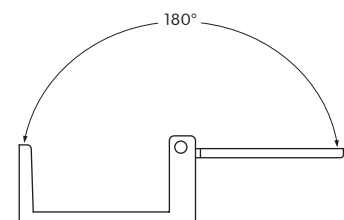

\* Minimum dimension allows opening of cover to 180°

## OPTIONAL ACCESSORIES

### Adaptors

**AT716**  
Single Pole  
Solder Lug/  
Quick Connect  
Terminals

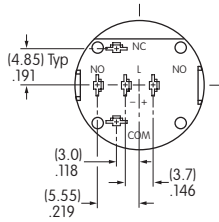
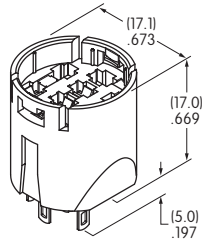

**AT717**  
Double Pole  
Solder Lug/  
Quick Connect  
Terminals

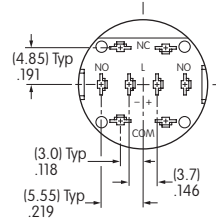
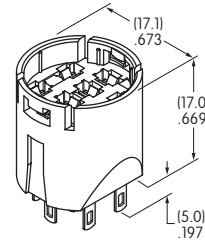

**AT718**  
Single Pole  
Straight PC  
Terminals

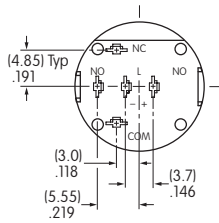
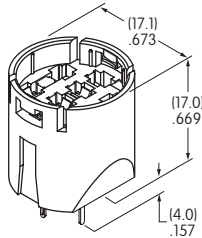

**AT719**  
Double Pole  
Straight PC  
Terminals

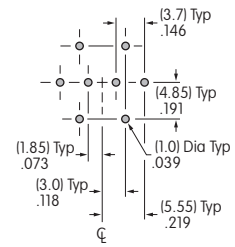
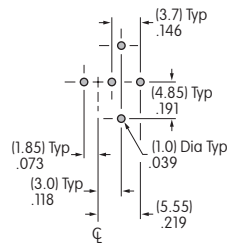
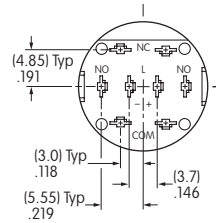
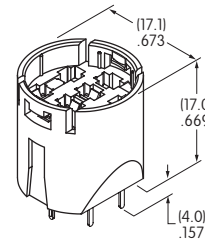

Material: Glass fiber reinforced polyamide      Note: Order adaptors separately

### Switch Dimensions Shown with Adaptor AT716

Dimension A:  
Solder Lug .197" (5.0mm); Straight PC .157" (4.0mm)

Panel thickness for YB Bushing Mount:  
.020" ~ .197" (0.5mm ~ 5.0mm)

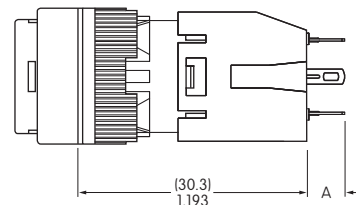

## ASSEMBLY INSTRUCTIONS

### Cap Assembly

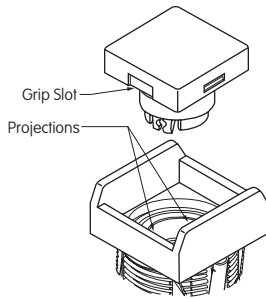

### LED Polarity & Orientation in Lamp Socket

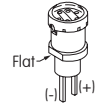
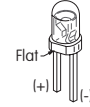
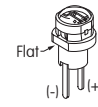
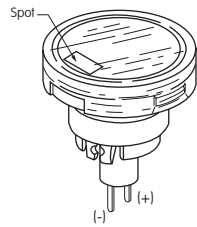
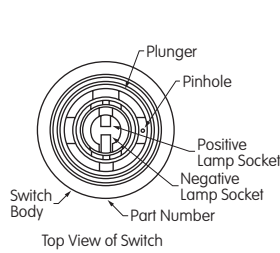

Spot Illuminated Cap with Built-in LED

LED AT628 AT634

LEDs AT625G AT631B AT632F

LED AT621

The following installation tools are available: AT106 Socket Wrench for bushing mounting (Overtightening the mounting nut AT092 may damage the switch housing.); AT109 Cap Extractor; AT111 Lamping Tool. Further details and dimensions are shown in the Accessories and Hardware section.

## LEGENDS

NKK Switches can provide custom legends for caps. Contact factory for more information.

### Suggested Printable Area for YB Lens

**Recommended Methods:** Laser Etch on clear lens, Screen Print or Pad Print on Lens. Epoxy based ink is recommended.

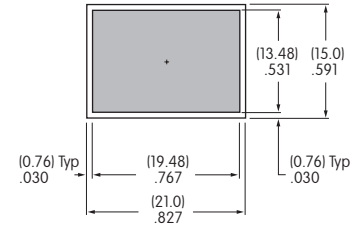
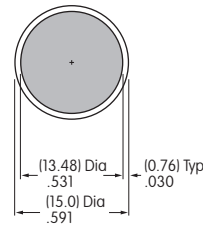
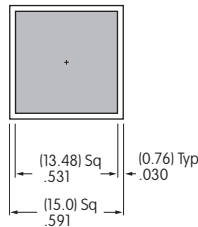

Shaded areas are printable areas.

### Suggested Printable Area for Film Insert

**Recommended Print Method:** Laser Print  
 Film Insert: Clear Polyester, 4 mil max. thickness

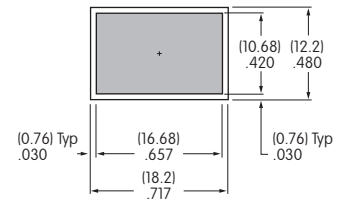
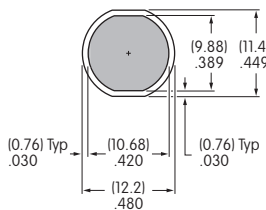
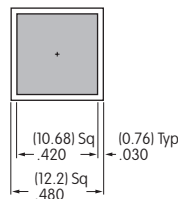
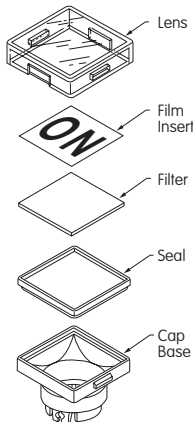

Shaded areas are printable areas.

Toggles  
 Rockers  
 Pushbuttons  
**D** Illuminated PB  
 Programmable  
 Keylocks  
 Rotaries  
 Slides  
 Tactiles  
 Tilt  
 Touch  
 Indicators  
 Accessories  
 Supplement